

У-У

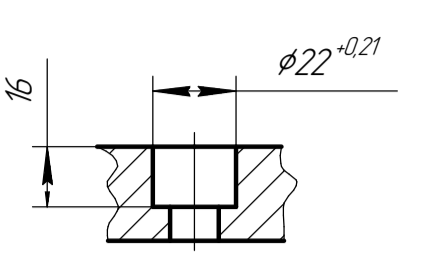

К-К

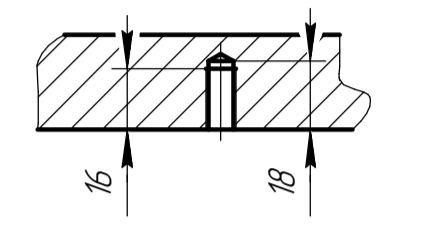

Н-Н (1:1)

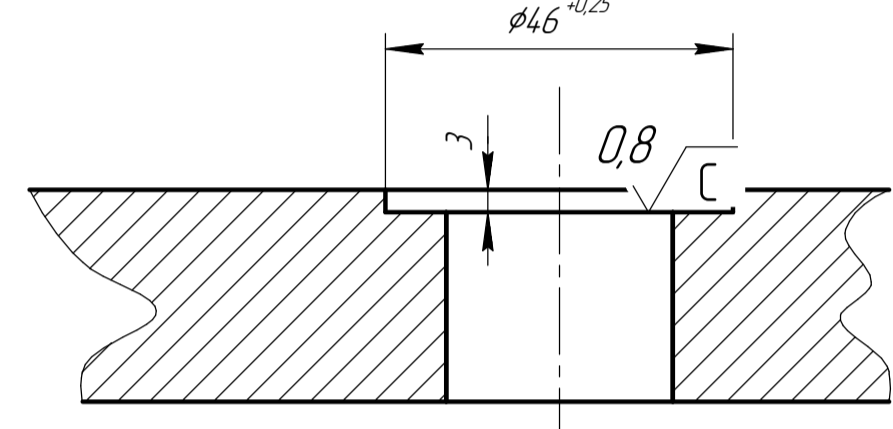

О-О

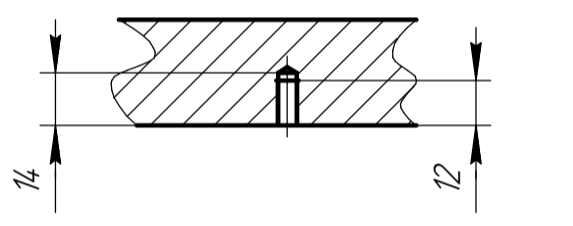

П-П (1:1)

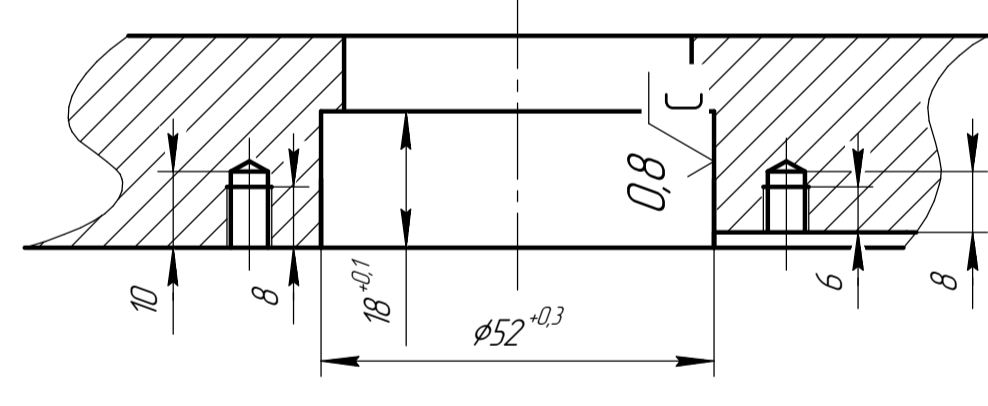

Р-Р

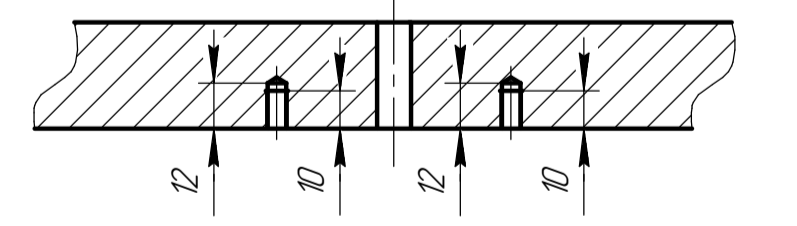

И-И (1:1)

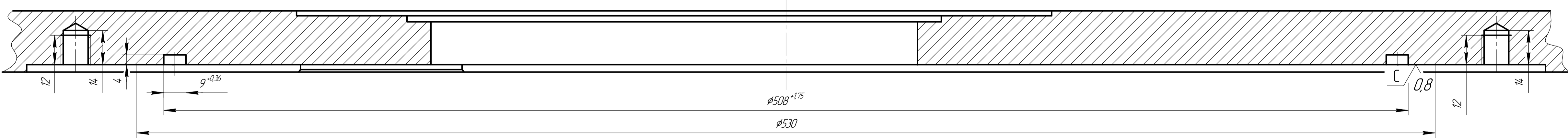

А-А

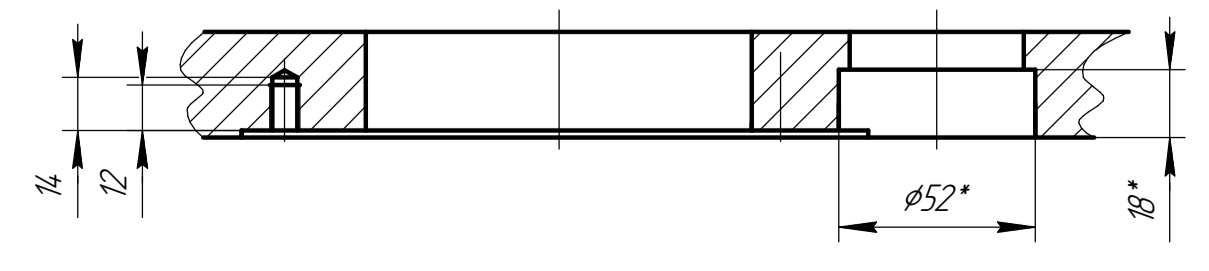

С-С (1:1)

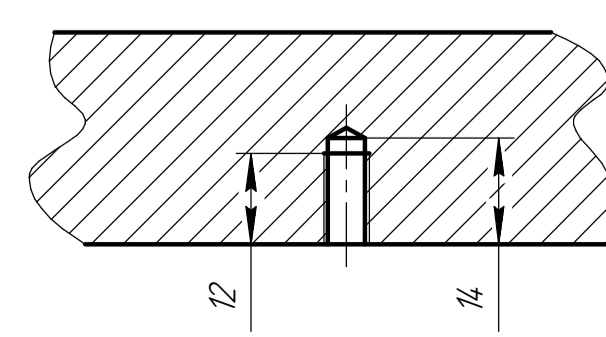

Т-Т (1:1)

