

Matrix-3700.005.P

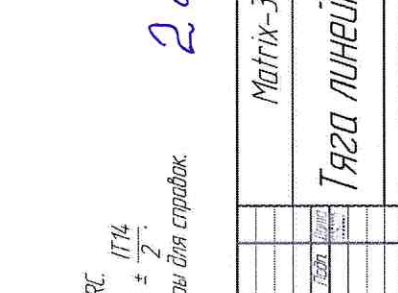
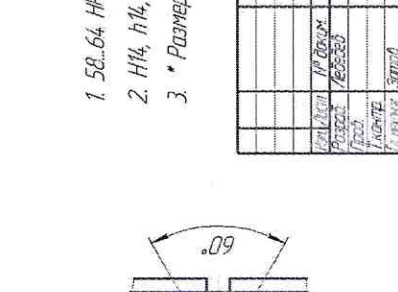
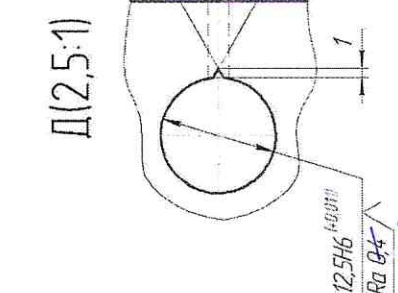
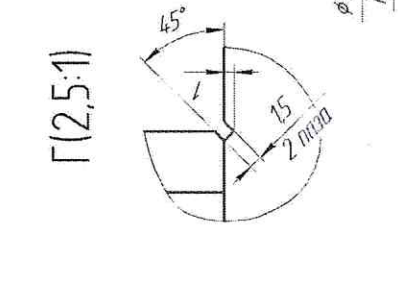
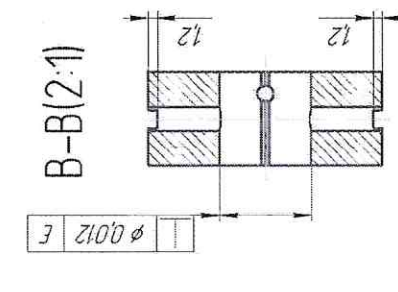
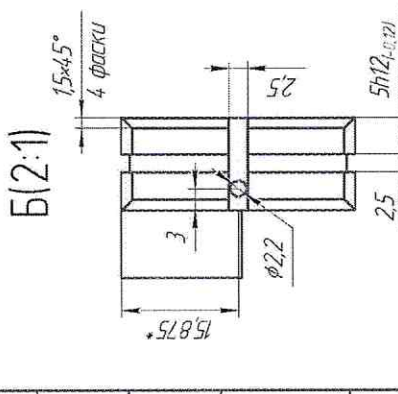
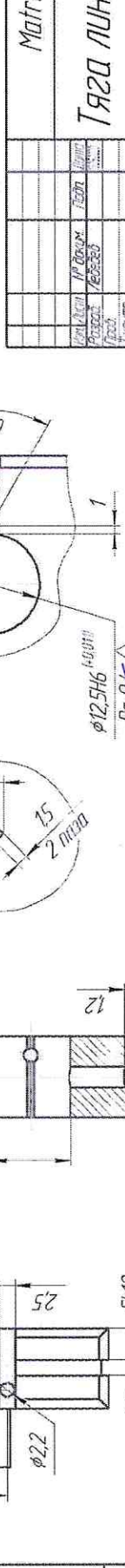
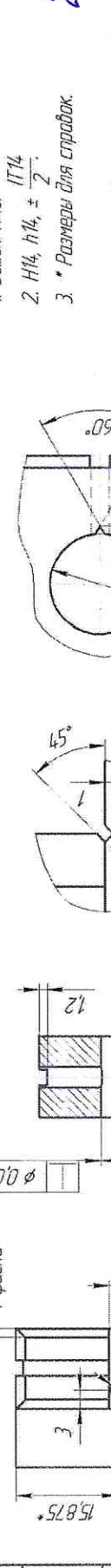
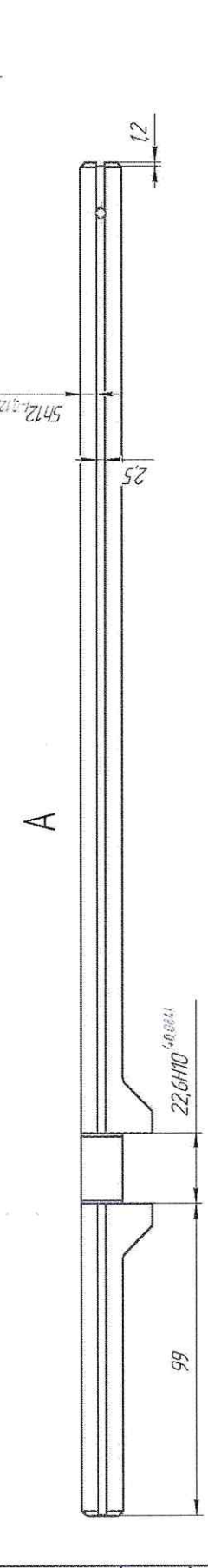
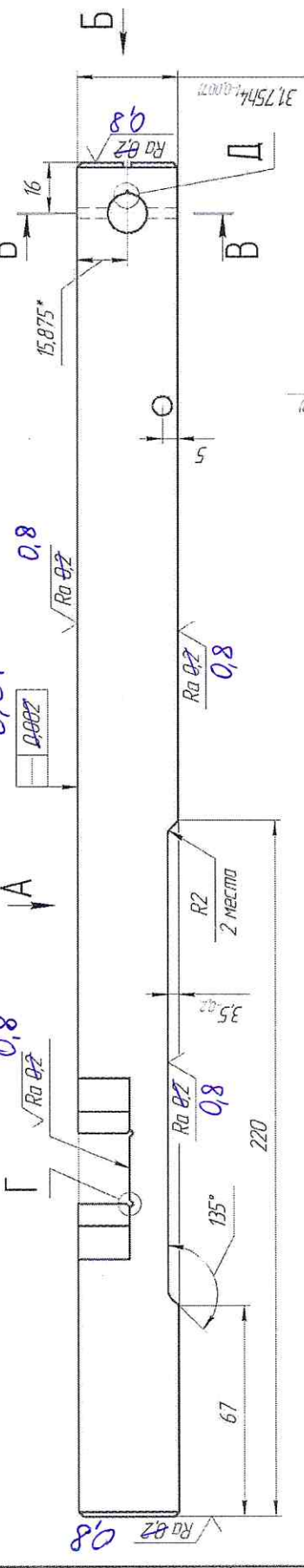
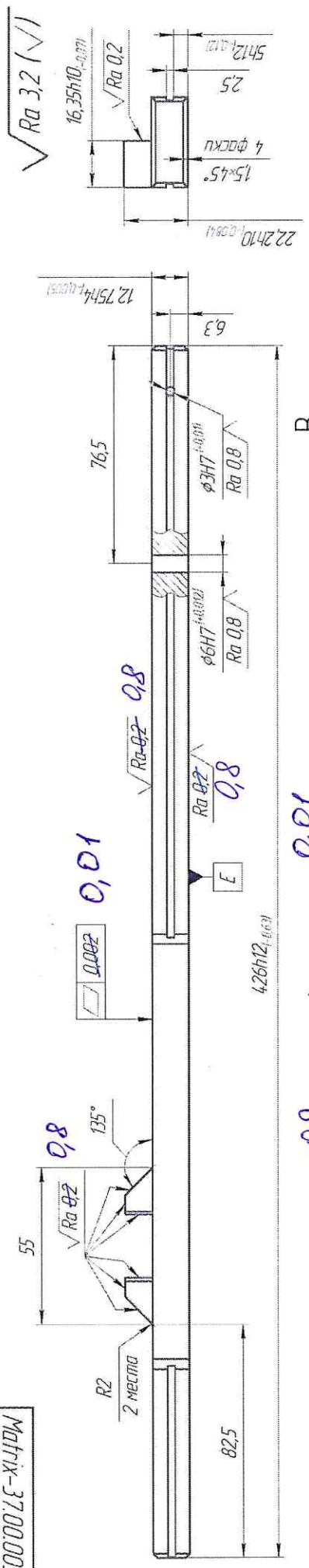

1. 58...64 HRC. П14
2. H14, h14, ± 2/100
3. \* Размеры для справок.

2 шт.

Matrix-3700.005.P		Матр. №	Лист	Уточнений
№	Изм.	Исполн.	Дата	Лист
1		П.В.В.	12.12.11	11
2		В.В.В.		7
3		В.В.В.		7
ТЯГО ЛИНЕЙКУ		Матр. №	Лист	Уточнений
Сталь ШХ15 ГОСТ 801-78		Матр. №	Лист	Уточнений